

EMILUX LIGHTING TECHNOLOGY CO.,LTD

Factory Add:A building,guanhuang road 1#,hengjiaotuo village,gaobu Town,DongGuan City,GuangDong Province,China.523269

[Http://www.emiluxled.com](http://www.emiluxled.com), info@emiluxled.com



LED SPOT LIGHT DATASHEET

EMILUX LIGHTING TECHNOLOGY CO.,LTD

Factory Add:A building,guanhuang road 1#,hengjiaotuo village,gaobu Town,DongGuan City,GuangDong Province,China.523269

[Http://www.emiluxled.com](http://www.emiluxled.com), info@emiluxled.com

Pro Hotel Spot lights 24W



PART NO.	ES4022
DESCRIPTION	Pro hotel Spot lights 24W
DATE	2023.02.06
	Triac/0-10v/dali dimming optional

EMILUX LIGHTING TECHNOLOGY CO.,LTD

Factory Add:A building,guanhuang road 1#,hengjiaotuo village,gaobu Town,DongGuan City,GuangDong Province,China.523269

[Http://www.emiluxled.com](http://www.emiluxled.com), info@emiluxled.com

● Datasheet:

Type	Product:	Pro hotel Spot light
	Model No.:	ES4022
Electronical	Input Voltage:	220-240V/AC
	Frequency:	50Hz
	Power:	24W
	Power Factor:	0.5
	Total Harmonic Distortion:	<5%
	Certificates:	CE,Rohs,ERP
Optical	Cover Material:	PC
	Beam Angle:	15/24/36/55°
	LED Quantity:	1pcs
	LED Package:	Bridgelux
	Luminous Efficiency:	≥90
	Color Temperature:	2700K/3000K/4000K
	Color Render Index:	≥90
Lamp Structure	Housing Material:	Aluminium diecasting
	Diameter:	Φ120*120*115mm
	Installation Hole:	Hole Cut Φ95*95mm
Surface Finished	Fished	powder painting(white color/customized color)
Water proof	IP	IP44
Others	Installation Type:	Recessed Type (refer to the Manual)
	Application:	Hotels, Supermarkets, Hospital, Aisles, Metro Station, Restaurants, Offices etc.
	Ambient Humidity:	≥80%R.H.
	Ambient Temperature:	-10℃~+40℃
	Storage Temperature:	-20℃~50℃
	Housing Temperature (working):	<70℃ (Ta=25℃)
	Lifespan:	50000H

EMILUX LIGHTING TECHNOLOGY CO.,LTD

Factory Add:A building,guanhuang road 1#,hengjiaotuo village,gaobu Town,DongGuan City,GuangDong Province,China.523269

[Http://www.emiluxled.com](http://www.emiluxled.com), info@emiluxled.com

Remarks:

1. All pictures&data above are only for your reference, models may slightly differ due to factory operation.
2. According to demand of Energy Star Rules and other Rules, Power Tolerance $\pm 10\%$ and CRI ± 5
- 3.Lumen Output Tolerance 10%
4. Beam Angle Tolerance $\pm 3^\circ$ (angle below 25°) or $\pm 5^\circ$ (angle above 25°)
5. All Data were gained at Ambient Temperature 25°C

- **Dimension:** (unit:mm $\pm 2\text{mm}$, The following picture is a reference picture)

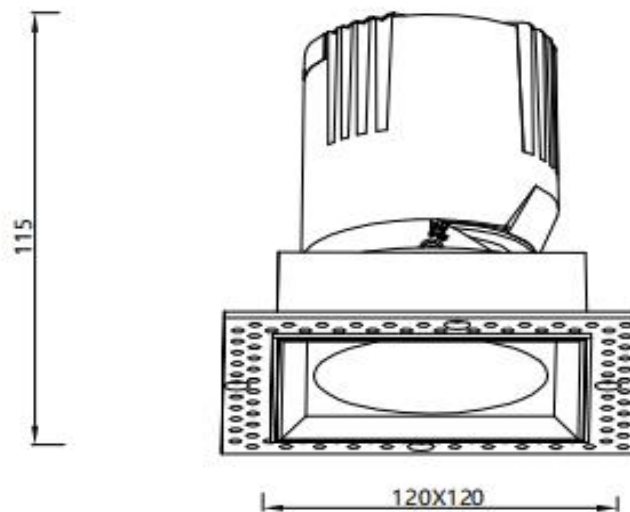

Model	Diameter ^① (caliber)	Diameter ^② (Maximum outer diameter)	Height ^③	Suggested Hole Cut	Net Weight (Kg)	Remark
ES4022	120	120	115	95*95	0.55	

EMILUX LIGHTING TECHNOLOGY CO.,LTD

Factory Add:A building,guanhuang road 1#,hengjiaotuo village,gaobu Town,DongGuan City,GuangDong Province,China.523269

[Http://www.emiluxled.com](http://www.emiluxled.com), info@emiluxled.com

● Installation: (Notes on installation and wiring)

Please pay more attention to the below instructions while installation, in order to avoid any possible Fire Hazard, Electric Shock or Personal harm。



Instructions:

1. Cut off Electricity before installation.
2. The product only used in DRY environment
3. Please do not block any objects on the lamp (distance scale within 70mm), which will definitely affect heat emission while lamp's working
4. Please double check before getting electricity on if wiring is 100% OK, make sure Voltage for lamp is right and no Short-Circuit.

● Wiring:

The Lamp can be directly connected to City Electric Supply and there'll be detailed User's Manual and Wiring Diagram.

EMILUX LIGHTING TECHNOLOGY CO.,LTD

Factory Add:A building,guanhuang road 1#,hengjiaotuo village,gaobu Town,DongGuan City,GuangDong Province,China.523269

[Http://www.emiluxled.com](http://www.emiluxled.com), info@emiluxled.com

Warning:

1. The Lamp is only for Indoor and Dry application, keep away from Heat, Steam, Wet, Oil, Corrosion etc, which may affect its permanence and shorten the lifespan.
2. Please strictly follow the instructions while installation to avoid any Hazard or damages.
3. Any installation, check or maintenance should be done by professional, please do not DIY if without enough related knowledge.
4. For better and long performance, please clean the lamp at least every half year with soft cloth. (Do not use Alcohol or Thinner as cleaner which may damage the lamp surface)
5. Do not expose the lamp under strong sunshine, heat sources or other high-temperature places, and storage boxes cannot be piled up exceeding the requirements.

● Carton Box Dimension:



Package	Dimension)
	LED Downlight
Inner Box	86*86*50mm
Outer Box	420*420*200mm 48PCS/carton
Net Weight	9.6kg
Gross Weight	11.8kg

Remarks:

1. If the loading qty less than 48pcs in a carton, pearl cotton material should be used to fill remaining space.
2. Accepted Loading Level is 6 (refer to the actual shown on carton box)
3. The package can be as per customer's specific demand.
4. All package data are only for reference, it may be differ due to actual packing situation.

Appication:

Hotels, Supermarkets, Hospital, Aisles, Metro Station, Restaurants, Offices etc.